

WEED EATER

® Trademark

ENGLISH



Please do not return unit to retailer.
Por favor, no devuelva el aparato al lugar de compra.
Veuillez ne pas retourner l'outil au détaillant.

1-800-554-6723

Register your product online at:
Registre su producto en línea en:
Enregistrez votre produit en ligne à l'adresse :
www.weedeater.com

Instruction Manual Manual de Instrucciones Manuel d'Instructions

245157



C US

WE EL-11

ESPAÑOL



WARNING:

Read and follow all Safety Rules and Operating Instructions before using this product. Read instructions carefully before assembling. Failure to do so can result in serious injury.

ADVERTENCIA:

Lea el manual del operador y siga todas las advertencias e instrucciones de seguridad. Antes de ensamblar el producto lea cuidadosamente el instructivo. El no hacerlo puede resultar en lesiones graves.

AVERTISSEMENT:

Veuillez lire le manuel de l'utilisateur et bien respecter tous les avertissements et toutes les instructions de sécurité. Bien lire les instructions avant d'assembler l'outil. Tout défaut de le faire pourrait entraîner des blessures graves.

WEED EATER
7349 Statesville Road
Charlotte, NC 28269

WEED EATER
850 Matheson Blvd. West
Mississauga, Ontario L5V 0B4

FRANÇAIS

115253326 Rev.3 05/07/10 JBW

SAFETY RULES

⚠ WARNING: When using electric gardening appliances, basic safety precautions must always be followed to reduce the risk of fire, electric shock, and serious injury. Read and follow all instructions.



SAFETY INFORMATION ON THE UNIT

This power unit can be dangerous! Operator is responsible for following the warnings and instructions in this manual and on the unit. Read entire instruction manual before using unit! Be thoroughly familiar with the controls and the proper use of the unit. Restrict the use of this unit to persons who read, understand, and follow unit and manual warnings and instructions. Never allow children to operate this unit. Close attention is necessary when used near children.

⚠ DANGER: Never use blades or flailing devices. Unit is designed for line trimmer use only. Use of any other accessories or attachments will increase the risk of injury.



⚠ WARNING: Trimmer line throws objects violently. You and others can be blinded/injured. Wear safety glasses, boots, and leg protection. Keep body parts clear of rotating line.

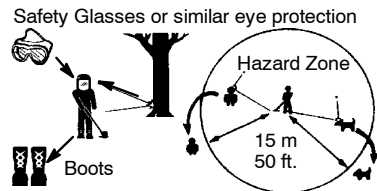

Keep children, bystanders, and animals 50 feet (15 meters) away. If approached stop unit immediately.

If situations occur which are not covered in this manual, use care and good judgement. If you need assistance, call 1-800-554-6723.

OPERATOR SAFETY

- Dress properly. Always wear safety glasses or similar eye protection when operating, or performing maintenance on your unit. (Safety glasses are available.) Always wear face or dust mask if operation is dusty. Always wear heavy, long pants, long sleeves, boots, and gloves. Do not go barefoot or wear sandals.
- Secure hair above shoulder length. Secure or remove loose clothing and jewelry or

clothing with loosely hanging ties, straps, tassels, etc. They can be caught in moving parts.

- Being fully covered also helps protect you from debris and pieces of toxic plants thrown by spinning line.
- Stay Alert. Do not operate unit when you are tired, ill, upset or under influence of alcohol, drugs, or medication. Watch what you are doing; use common sense.
- Avoid unintentional starting of the unit. Never carry unit with your finger on the switch. Be sure the switch is in the OFF position and never touch the switch when connecting extension cord.

ELECTRICAL SAFETY

⚠ WARNING: Avoid a dangerous environment. To reduce the risk of electrical shock, do not use in rain, in damp or wet locations, or around swimming pools, hot tubs, etc. Do not expose to snow, rain, or water to avoid the possibility of electrical shock.

- Use a voltage supply as shown on unit.
- Avoid dangerous situations. Do not use in the presence of flammable liquids or gases to avoid creating a fire or explosion and/or causing damage to unit.
- To reduce the risk of electrical shock, this equipment has a polarized plug (one blade is wider than the other) and will require the use of a polarized extension cord. The appliance plug will fit into a polarized extension cord only one way. If the plug does not fit fully into the extension cord, reverse the plug. If the plug still does not fit, obtain a correct polarized extension cord. A polarized extension cord will require the use of a polarized wall outlet. This plug will fit into the polarized wall outlet only one way. If plug does not fit fully into the wall outlet, reverse the plug. If it still does not fit, contact a qualified electrician to install the proper wall outlet. Do not change the equipment plug, extension cord receptacle, or extension cord plug in any way.
- To reduce risk of electrical shock, use extension cords specifically marked as suitable for outdoor appliances having electrical rating not less than the rating of unit. Cord must be marked with suffix "W-A" (in Canada "W"). Make sure your extension cord is in good condition. Inspect extension cord before use and replace if damaged. Do not use a damaged cord. Cord insulation must be intact with no cracks or deterioration. Plug connectors must be undamaged. An undersized extension cord will cause a drop in line voltage resulting in loss of power and overheating. If in doubt, use the next heavier gauge. The lower the gauge number, the heavier the cord (see SELECT AN EXTENSION CORD in the OPERATION section).
- Do not use multiple cords.

- Do not abuse cord. Never carry the unit by the extension cord or yank extension cord to disconnect unit.
- Use cord retainer to prevent disconnection of extension cord from unit and possible damage to the unit due to plug movement (see ATTACH THE EXTENSION CORD TO YOUR TRIMMER in the OPERATION section).
- Do not use the unit if the switch does not turn the unit on and off properly. Repairs to the switch must be made by your authorized service dealer.
- Keep the extension cord clear of operator and obstacles at all times. Do not expose cords to heat, oil, water, or sharp edges.
- To avoid the possibility of electric shock, avoid body contact with any grounded conductor, such as metal fences or pipes.
- Ground Fault Circuit Interrupter (GFCI) protection should be provided on circuit or outlet to be used. Receptacles are available having built-in GFCI protection and may be used for this measure of safety.

UNIT SAFETY

- Inspect unit before use. Replace damaged parts. Make sure all handles, guards, and fasteners are in place and securely fastened. Parts that are damaged must be repaired or replaced by an authorized service dealer. These include head parts that are cracked, or chipped, guards, and any other part that is damaged.
- Do not repair unit yourself.
- Use only 0.065 inch (1.65 mm) diameter recommended trimmer line (see USER REPLACEABLE SERVICE PARTS in the SERVICE AND ADJUSTMENTS section). Never use wire, rope, string, etc.
- Use specified trimmer spool. Make sure spool is properly installed and all parts are securely fastened.
- Use only WEED EATER replacement parts and accessories as recommended.

CUTTING SAFETY

- ⚠ WARNING:** Inspect area to be cut. Remove objects (rocks, broken glass, nails, wire, string, etc.) which can be thrown or become entangled in cutting head.
- Do not overreach or stand on unstable support. Keep firm footing and balance.
 - Keep the cutting head below waist level. Do not raise handles above your waist. Cutting head can come dangerously close to your body.
 - Keep away from cutting head and spinning line.
 - Use unit properly. Use only for trimming, scalping, and mowing. Do not force unit. It will do the job better and with less risk of injury at the rate for which it was designed.
 - Use only in daylight or in good artificial light.

MAINTENANCE SAFETY

- ⚠ WARNING:** Disconnect unit from the power supply before performing maintenance, or when changing trimmer line.
- Maintain unit according to recommended procedures. Keep cutting line at proper length. Follow instructions for changing trimmer line.
 - Have all service and maintenance not explained in this manual performed by an authorized service dealer to avoid creating a hazard.
 - Never douse or squirt the unit with water or any other liquid. Clean unit and labels with a damp sponge. Keep handles dry, clean, and free from oil and grease.
 - Keep the air vents clean and free of debris to avoid overheating the motor. Clean after each use.

TRANSPORTING AND STORAGE

- Stop the unit and disconnect the power source when not in use.
- Carry the unit with motor stopped.
- Store the unit so the line limiter blade (on underside of shield) cannot cause injury.
- Store unit indoors in a high, dry place out of the reach of children. Store unit unplugged.
- Do not hang unit so that the trigger switch is depressed.

DOUBLE INSULATION CONSTRUCTION

This unit is double insulated to help protect against electric shock. Double insulation construction consists of two separate "layers" of electrical insulation instead of grounding. Tools built with this insulation system are not intended to be grounded. No grounding means is provided on this unit, nor should a means of grounding be added to this unit. As a result, the extension cord used with your unit can be plugged into any standard 120 volt electrical outlet.

Safety precautions must be observed when operating any electrical tool. The double insulation system only provides added protection against injury resulting from an internal electrical insulation failure.

- ⚠ WARNING:** All electrical repairs to this unit, including housing, switch, motor, locking sleeve assembly, wires, etc., must be diagnosed and repaired by qualified service personnel. Replacement parts for a double insulated appliance must be recommended by the manufacturer. A double insulated appliance is marked with the words "double insulation" or "double insulated". The symbol (square within a square)  may also be marked on the appliance. Failure to have the unit repaired by qualified service personnel can cause the double insulation construction to become ineffective and result in serious injury.

SAVE THESE INSTRUCTIONS

ASSEMBLY

⚠ WARNING: If received assembled, review all assembly steps to ensure your unit is properly assembled and all fasteners are secure.

TUBE ASSEMBLY

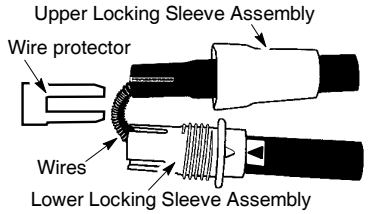

1. Remove the wire protector from the tubes and discard.
2. Align upper tube groove with triangle on lower locking sleeve assembly. Push tubes together until they snap into place.

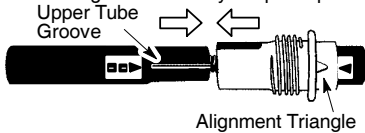

3. Try to pull tubes back apart. If the tubes do not come apart, they are properly snapped into place. If the tubes come apart, repeat step 1 and push until the tubes snap into place.
4. Slide upper locking sleeve assembly over lower locking sleeve assembly and tighten by turning clockwise.

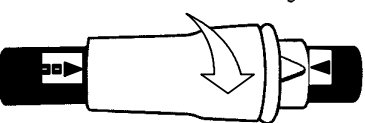
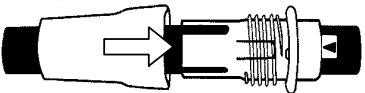

5. Ensure locking sleeve assembly and alignment decals appear as illustrated below.

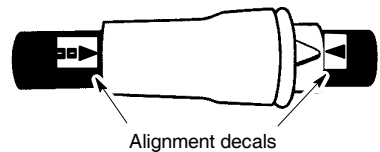

⚠ WARNING: Failure to completely enclose excess wires in upper tube during assembly of the unit may result in damage to the wires and/or the unit or serious injury to the operator including electrocution.

⚠ WARNING: The upper and lower tubes must be snapped together, remain permanently assembled together and the locking sleeve assembly must be fully tightened before and during use to avoid serious injury to the operator and/or damage to the unit. DO NOT attempt to disassemble unit after initial assembly.

INSTALLATION OF ASSIST HANDLE

1. Place unit on a flat surface.
2. Remove knob and bolt from kit.
3. Firmly push the assist handle over the tube. To make installation easier, tilt handle toward trigger housing while pushing down (see illustration).
4. Install bolt in handle. Thread knob onto bolt.
5. Adjust the handle up or down the tube to a comfortable position; tighten knob securely.

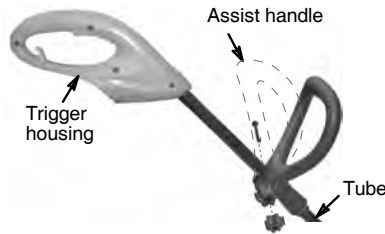

ATTACHING THE SHIELD

⚠ WARNING: The shield must be properly installed. The shield provides partial protection from the risk of thrown objects to the operator and others. Your unit is equipped with a line limiter blade, which cuts excess line to the proper length while running. The line limiter blade (on underside of shield) is sharp and can cut you.

NOTE: If shield is not properly installed, damage to unit (including motor failure) will result.

1. Insert the shield onto the motor housing. Ensure the cutting head remains free to rotate and the line is not caught between the shield and the motor housing (See following illustration).
2. Twist the shield as illustrated until the hole in the shield aligns with the hole in the housings. Make sure the shield is assembled to the unit as shown in the illustration below and in the KNOW YOUR UNIT section of this manual.
3. Install bolt into shield and motor housing as shown. Tighten securely.

ALIGN INSTALLATION HOLES

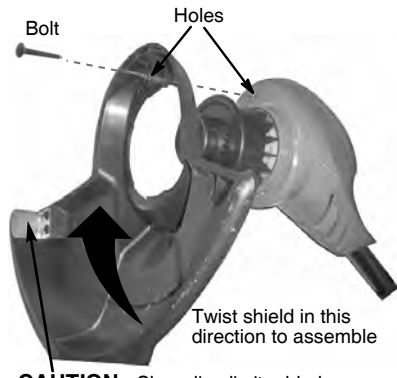

CAUTION: Sharp line limiter blade

OPERATION

KNOW YOUR TRIMMER

READ THIS INSTRUCTION MANUAL AND SAFETY RULES BEFORE OPERATING YOUR UNIT. Compare the illustrations with your unit to familiarize yourself with the location of the various controls and adjustments. Save this manual for future reference.

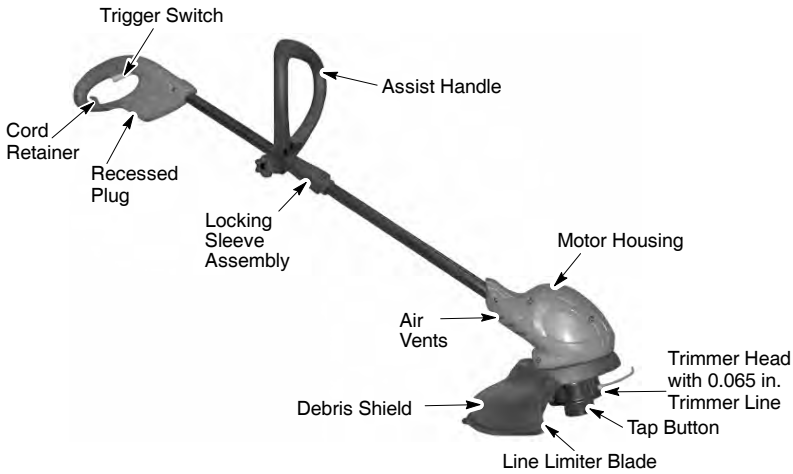

RECESSED PLUG

The RECESSED PLUG is where you attach your extension cord to the unit.

TRIGGER SWITCH

The TRIGGER SWITCH is used to turn on the unit. Squeeze the trigger switch to operate the unit. Release to stop.

LINE LIMITER BLADE

The LINE LIMITER BLADE cuts the cutting line to the proper cutting length.

ASSIST HANDLE

The ASSIST HANDLE is used to help hold and guide the unit.

TRIMMER HEAD

The TRIMMER HEAD holds cutting line and rotates during operation.

TAP BUTTON

The TAP BUTTON is used to advance the cutting line during operation and to remove the spool during line replacement.

OPERATING INSTRUCTIONS

Use only a voltage supply as specified on your unit.

SELECT AN EXTENSION CORD

Extension Cord Gauge Chart	
Length of Cord	Gauge
25 Ft. (7.5 m)	18 Gauge
50 Ft. (15 m)	16 Gauge
100 Ft. (30 m)	16 Gauge

Extension cords are available for this unit.

ATTACH THE EXTENSION CORD TO YOUR TRIMMER

Loop your extension cord through the handle and around the hook as shown. Insure the plug and cord are firmly and fully engaged.

Cord Retainer

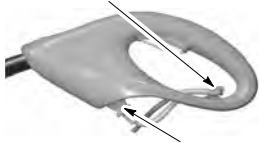

Extension Cord

CORRECT OPERATING POSITION

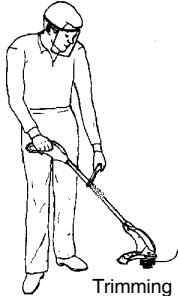

Trimming

WARNING: Always wear eye protection. Never lean over the trimmer head. Rocks or debris can ricochet or be thrown into eyes and face and cause blindness or other serious injury.

When operating unit, stand as shown and check for the following:

- Wear eye protection and heavy clothing.
- Hold trigger handle with right hand and assist handle with left hand.
- Keep unit below waist level.
- Cut only from your right to your left to ensure debris is thrown away from you. Without bending over, keep line near and parallel to the ground and not crowded into material being cut.

ADVANCING THE CUTTING LINE

Advance line by tapping bottom of cutting head lightly on the ground while unit is running at full speed. A metal line limiter blade attached to the shield will cut the line to the proper length.

WARNING: Use only 0.065 inch (1.65 mm) diameter line. Other sizes of line will not advance properly and will result in improper cutting head function or can cause serious injury. Do not use other materials such as wire, string, rope, etc. Wire can break off during cutting and become a dangerous missile that can cause serious injury. See page 2 for warning concerning other cutting devices.

TRIMMING

Hold the bottom of the trimmer head about 3 inches (8 cm) above the ground and at an angle. Allow only the tip of the line to make contact. Do not force trimmer line into work area.

Trimming

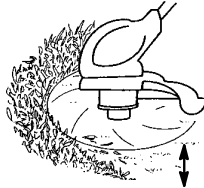

3 in. (8 cm)
Above Ground

SCALPING

The scalping technique removes unwanted vegetation down to the ground. Hold the bottom of the trimmer head about 3 inches (8 cm) above the ground and at an angle. Allow the tip of the line to strike the ground around trees, posts, monuments, etc. This technique increases line wear.

Scalping

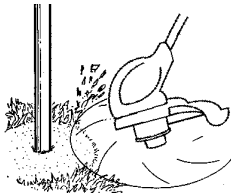

MOWING

Your trimmer is ideal for mowing in places conventional lawn mowers cannot reach. In the mowing position, keep the line parallel to the ground. Avoid pressing the head into the ground as this can scalp the ground and damage the tool.

Mowing

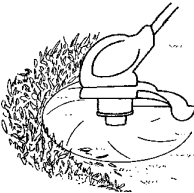

SWEEPING

The fanning action of the rotating line can be used for a quick and easy clean up. Keep the line parallel to and above the surfaces being swept and move the tool from side to side.

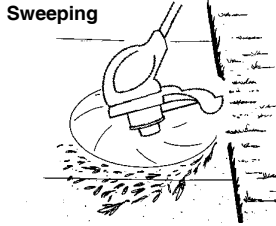

MAINTENANCE

WARNING: Disconnect unit from the power source before performing maintenance.

GENERAL RECOMMENDATIONS

The warranty on this unit does not cover items that have been subjected to operator abuse or negligence. To receive full value from the warranty, the operator must maintain unit as instructed in this manual. Various adjustments will need to be made periodically to properly maintain your unit.

BEFORE EACH USE

CHECK FOR LOOSE FASTENERS AND PARTS

- Housing Screws
- Locking Sleeve Assembly
- Assist Handle
- Debris Shield

CHECK FOR DAMAGED OR WORN PARTS

Contact an authorized service dealer for replacement of damaged or worn parts.

- Trigger Switch - Ensure switch functions properly by pressing and releasing the trigger switch. Make sure motor stops.
- Debris Shield - Discontinue use of unit if debris shield is damaged.

AFTER EACH USE

INSPECT AND CLEAN UNIT AND LABELS

- After each use, inspect complete unit for loose or damaged parts. Clean the unit using a damp cloth with a mild detergent.
- Wipe off unit with a clean dry cloth.

SERVICE AND ADJUSTMENTS

REPLACING THE LINE

1. Disconnect the unit from the power source.
2. Remove the spool by firmly pulling on the tap button.
3. Clean entire surface of hub and spool.
4. Replace with a pre-wound spool or cut a length of 30 feet of 0.065" (1.65 mm) diameter WEED EATER brand line. Use of heavier lines could overload and damage unit.

WARNING: Never use wire, rope, string, etc., which can break off and become a dangerous missile.

5. Insert one end of the line about 1/2 inch (1 cm) into the small hole inside the spool.
6. Wind the line evenly and tightly onto the spool. Wind in the direction of the arrow found on the spool.
7. Push the line into the notch, leaving 3 to 5 inches (7 - 12 cm) unwound.
8. Insert the line into the exit hole in the hub as shown in the illustration.
9. Align the notch with the line exit hole.
10. Push the spool into the hub until it snaps into place.

11. Pull on the line extending outside the hub to release it from the notch; otherwise, the unit will not function properly.

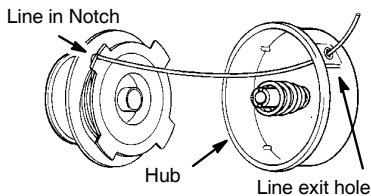
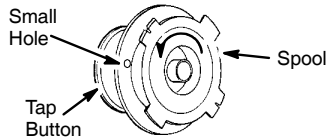

USER REPLACEABLE SERVICE PARTS

REPLACEMENT PART	PART NUMBER
Spool with 0.065" Trimmer Line	952701663
Assist Handle	574473001
Bolt Carriage, M6x1	574473201
Knob	574473101
Shield Assembly	574471501
Bolt	574471601

STORAGE

⚠ WARNING: Perform the following steps after each use.

- Stop the unit and disconnect the power source when not in use.
- Carry the unit with motor stopped.
- Store the unit so the line limiter blade cannot cause injury.

- Store unit and extension cord indoors in a high, dry place out of the reach of children. Store unit unplugged.
- Store unit with all guards in place. Position unit so that any sharp object cannot accidentally cause injury.

TROUBLESHOOTING TABLE

⚠ WARNING: Always stop unit and disconnect from the power source before performing all of the recommended remedies below except remedies that require unit to be operating.

TROUBLE	CAUSE	REMEDY
Trimmer head stops under a load or does not turn when switch is pressed.	<ol style="list-style-type: none"> 1. Crowding trimmer line against material being cut. 2. Electrical failure. 3. Thrown circuit breaker. 4. Debris stopping head. 	<ol style="list-style-type: none"> 1. Allow tip of line to do the cutting. 2. Contact your authorized service dealer. 3. Check Breaker Box. 4. Remove debris.
Line does not advance or breaks while cutting.	<ol style="list-style-type: none"> 1. Line improperly routed in head. 2. Line improperly wound into spool. 3. Incorrect line size 4. Not enough line outside of head. 5. Dirt buildup on unit. 	<ol style="list-style-type: none"> 1. Check line routing. 2. Rewind line tightly and evenly. 3. Use only 0.065 in. (1.65 mm) dia. line. 4. Remove cover and pull 4 inches (10 cm) of line out of head. 5. Clean unit.
Line welds onto spool.	<ol style="list-style-type: none"> 1. Line size is incorrect. 2. Incorrect spool. 3. Line is being crowded against material being cut. 	<ol style="list-style-type: none"> 1. Use only 0.065 in. (1.65 mm) dia. line. 2. Replace with correct spool. 3. Cut with tip of line fully extended.
Line releases continuously.	<ol style="list-style-type: none"> 1. Line improperly routed in head. 2. Spool damaged. 	<ol style="list-style-type: none"> 1. Check line routing. 2. Replace spool.
Line usage is excessive.	<ol style="list-style-type: none"> 1. Line improperly routed in head. 2. Line size is incorrect. 3. Crowding line against material being cut. 4. Spool worn or damaged. 	<ol style="list-style-type: none"> 1. Check line routing. 2. Replace spool. 3. Cut with tip of line fully extended. 4. Replace spool.
Line pulls back into head.	<ol style="list-style-type: none"> 1. Too little line outside of head. 2. Line size incorrect. 	<ol style="list-style-type: none"> 1. Remove cover and pull 4 inches (10 cm) of line outside of head. 2. Use only 0.065 in. (1.65 mm) dia. line.

LIMITED WARRANTY

WEED EATER, a division of Husqvarna Consumer Outdoor Products N.A., Inc., warrants to the original consumer purchaser that each new **WEED EATER** brand electric or cordless product is free from defects in material and workmanship and agrees to repair or replace under this warranty any defective **WEED EATER** brand electric or cordless product within two (2) years from the original date of purchase.

If your **WEED EATER** brand electric or cordless product should fail within the limited warranty period, you may return it in complete condition, prepaid, with proof of purchase, to the dealer from whom it was purchased for repair or replacement at the option of **WEED EATER**.

This warranty is not transferable and does not cover damage or liability caused by improper handling, improper maintenance or alteration, or the use of accessories and/or attachments not specifically recommended by **WEED EATER** for this product. Additionally, this warranty does not cover parts that will wear and require replacement with reasonable use during the warranty period. This warranty does not cover pre-delivery set-up or normal adjustments explained in the instruction manual.

Should you have any unanswered questions concerning this warranty, please contact:

WEED EATER, a division of Husqvarna Consumer Outdoor Products N.A., Inc
7349 Statesville Road
Charlotte, NC 28269
1-800-554-6723

In Canada, contact:

WEED EATER
850 Matheson Blvd. West
Mississauga, Ontario L5V 0B4

Giving the model number, serial number and date of purchase of your product and the name and address of the authorized dealer from whom it was purchased.

THIS WARRANTY GIVES YOU SPECIFIC LEGAL RIGHTS, AND YOU MAY HAVE OTHER RIGHTS WHICH VARY FROM STATE TO STATE.

NO CLAIMS FOR CONSEQUENTIAL OR OTHER DAMAGES WILL BE ALLOWED, AND THERE ARE NO OTHER EXPRESS WARRANTIES EXCEPT THOSE EXPRESSLY STIPULATED HEREIN.

SOME STATES DO NOT ALLOW LIMITATIONS ON HOW LONG AN IMPLIED WARRANTY LASTS OR THE EXCLUSION OR LIMITATIONS OF INCIDENTAL OR CONSEQUENTIAL DAMAGES, SO THE ABOVE LIMITATIONS OR EXCLUSION MAY NOT APPLY TO YOU.

This is a limited warranty within the meaning of that term as defined in the Magnuson-Moss Act of 1975.

The policy of **WEED EATER** is to continuously improve its products. Therefore, **WEED EATER** reserves the right to change, modify, or discontinue models, designs, specifications, and accessories of all products at any time without notice or obligation to any purchaser.